

SML

Socketless cast iron
waste water system for
building construction

Product information



SML

Socketless cast iron
waste water system for
building construction

SML product information

The all-rounder

SML is the classic socketless cast iron waste water system from RSP®, consisting of a total of more than 260 pipes and fittings. For decades, SML systems have been a popular choice for use in numerous building types including airports, exhibition centres, offices, hotels and residential construction, and thanks to their superb technical

characteristics they always do their job reliably.

Quality approved

RSP® SML pipes and fittings have very high-quality surfaces that give them outstanding flow properties. Their coatings meet quality criteria that go far beyond what is required by the applicable standard, with adherence to these criteria

confirmed in third-party control by the testing and surveillance body LGA.

The entire RSP® system has been tested and certified for its reaction to fire – one of its most important properties – by the Leipzig Institute for Materials Research and Testing (MFPA Leipzig) according to the latest version of DIN EN 877/ A1, dated January 2010.

Tough and cost-effective

RSP® products are quality-tested and represent good value for money, thanks to their good sound insulation characteristics (30 dB(A)), resistance to wear, mechanical strength and very low coefficient of expansion of just 0.0105 mm/mK.

Coatings and installation



Coatings

RSP® SML fittings are coated inside and out with a specially-developed, reddish-brown epoxy resin coating, which is applied to the hot fitting in powder form and then cured to ensure perfect adhesion. This method gives a completely smooth, almost entirely non-porous surface that offers a level of resistance to the substances usually encountered in building waste water systems that goes far beyond what is required by the standard.

SML cast iron pipes have an additional external protective coating in conformity with the relevant standard and are coated on the inside with high-quality epoxy resin.

This coating not only complies with DIN EN 877, but also satisfies much tougher requirements as demonstrated by our certificates from TÜV Rheinland LGA Products GmbH (available at www.rsp-pipes.com/download). Even in today's age of ever more aggressive waste waters, these systems are guaranteed to deliver outstanding service life.

Coating thicknesses

Fittings:

External and internal from 100 to 200 µm (epoxy resin powder coating)

Pipes:

Internal 100-150 µm (epoxy resin)
External 80-100 µm (epoxy finishing coat)

Installation

SML cast iron pipes are supplied in a length of 3000 mm. They can be easily cut to size on the construction site using a pipecutter, circular or band saw, or – under certain circumstances – an angle grinder.

Please ensure the cut is precise and square to guarantee hassle-free installation of pipes and fittings and maximum leaktightness (it is advisable to take measures to seal the cut edges).

RSP® products are compatible with all products that comply with the standards relevant to SML systems.

The installation method used depends on the circumstances at the place of installation. You can find relevant tips for installation in our “Technology and installation” catalogue; alternatively, please feel free to contact us directly.

Generally the standards DIN EN 12056, DIN 1986 and DIN EN 1610 are mandatory for discharge systems for buildings, and for drains.

Questions? We can help.

You can find more information on planning and installation in our “Technology and installation” catalogue.

Contents | Product overview

Design dimensions (DIN EN 877 and DIN 19522)	6
Pipe (3000 mm, 1000 mm)	6
Bend 15°	7
Bend 30°	7
Bend 45°	7
Bend 68°	8
Bend 88°	8
Bend 88° with 250 mm spigot	8
Double bend 88° (2 x 44°)	8
Bend with 250 mm oblong (2 x 44°)	9
Recirculated air bend 135°	9
Offset bend 65 mm	9
Offset bend 130 mm	9
Offset bend 200 mm	9
Trap – horizontal/vertical	10
Trap – vertical	10
Plug	10
Plug with gripper clamp	10
Branch 45°	11
Branch 70°	12
Branch 88°	12
Branch 88° with long spigot	12
Double branch 70°	13
Double branch 88°	13
Corner branch 88°	13
Corner branch 88° with long spigot	13
Combination branch 90°	13
Short pipe with round access door	13
Short pipe with rectangular access door	14
Stack support pipe (no rubber)	14
Stack support bracket (with rubber)	14
Reducing pipe eccentric	15
WC bend 90°	15
Connection bend 90°	15
Swept bend 88°, long/medium	17
Rest bend 88°	17
Access bend, long	17
Access bend, short	17
Ventilation bend 88°, radial	17
Ventilation bend 88°, axial	17
Plain trap	18
Push-in plug	18
Swept entry branch 88°	18
Double branch 45°	18

Design dimensions (DIN EN 877 and DIN 19522)

Nominal size	Outside diameter		Wall thickness				Insertion length (sealing zone)	Pipe weight (empty)	Surface area
			Pipe		Fitting				
DN*	DE*	Tolerance*	E*	Tolerance*	e*	Tolerance*	t*	Approx. kg/m	Per m
40	48	+2/-1	3.0	-0.5	4.0	-0.7	30	3.1	0.15
50	58	+2/-1	3.5	-0.5	4.2	-0.7	30	4.3	0.18
70	78	+2/-1	3.5	-0.5	4.2	-0.7	35	5.7	0.25
80	83	+2/-1	3.5	-0.5	4.2	-0.7	35	6.2	0.28
100	110	+2/-1	3.5	-0.5	4.2	-0.7	40	8.3	0.35
125	135	+2/-2	4.0	-0.5	4.7	-1.0	45	11.7	0.42
150	160	+2/-2	4.0	-0.5	5.3	-1.3	50	14.0	0.50
200	210	+2/-2	5.0	-1.0	6.0	-1.5	60	23.0	0.65
250	274	+2.5/-2.5	5.5	-1.0	7.0	-1.5	70	33.0	0.85
300	326	+2.5/-2.5	6.0	-1.0	8.0	-1.5	80	43.2	1.02
400	429	+2/-3	6.3	-1.3	8.1	-1.7	80	59.8	1.34

*All dimensions in mm.

Pipe

(Length = 3000 mm)

DN	kg	Item no.
40	9.0	ROHRDN040
50	13.0	ROHRDN050
70	17.0	ROHRDN070
DE75	17.0	ROHRDN068
80	18.0	ROHRDN080
100	25.0	ROHRDN100
125	35.0	ROHRDN125
150	42.0	ROHRDN150
200	69.0	ROHRDN200
250	99.0	ROHRDN250
300	130.0	ROHRDN300
400	182.0	ROHRDN400

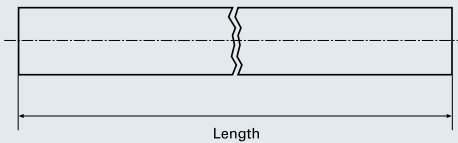

Pipe

(Length = 1000 mm)

DN	kg	Item no.
70	7.0	REGENR070
80	7.0	REGENR080
100	8.0	REGENR100
125	13.0	REGENR125
150	14.0	REGENR150
200	23.0	REGENR200

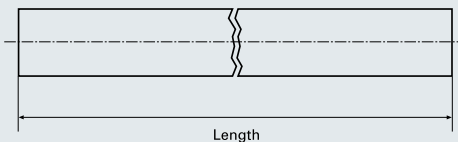

Bend 15°

DN	A	kg	Item no.
50	40	0.4	5015
70	45	0.6	7015
DE75	45	0.6	7515
80	45	0.7	8015
100	50	1.0	10015
125	60	1.7	12515
150	65	2.5	15015
200	80	4.6	20015
DE75/22°	45	0.6	7522

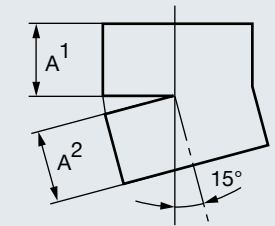

Bend 30°

DN	A	kg	Item no.
50	45	0.5	5030
70	50	0.7	7030
DE75	50	0.7	7530
80	50	0.8	8030
100	60	1.3	10030
125	70	2.0	12530
150	80	3.0	15030
200	95	5.4	20030
250	110	9.7	25030
300	130	15.5	30030

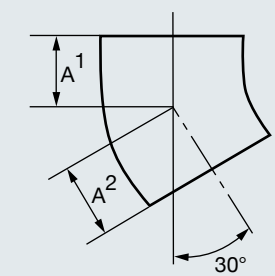

Bend 45°

DN	A	kg	Item no.
40	50	0.4	4045
50	50	0.5	5045
70	60	0.9	7045
DE75	60	0.8	7545
80	60	1.0	8045
100	70	1.6	10045
125	80	2.3	12545
150	90	3.5	15045
200	110	6.2	20045
250	130	10.3	25045
300	155	17.3	30045
400	247	36.0	40045

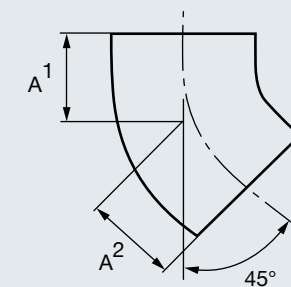

Bend 68°

DN	A	kg	Item no.
50	65	0.7	5070
70	75	1.1	7070
80	80	1.1	8070
100	90	1.9	10070
125*	105	2.9	12570
150	120	4.3	15070
200	145	7.7	20070

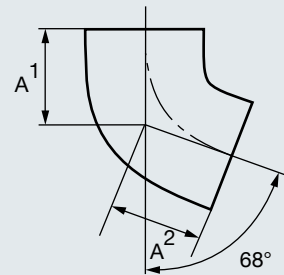

*Discontinued.

Bend 88°

DN	A	kg	Item no.
40	70	0.5	4088
50	75	0.7	5088
70	90	1.2	7088
DE75	90	1.1	7588
80	95	1.4	8088
100	110	2.1	10088
125	125	3.2	12588
150	145	4.9	15088
200	180	8.8	20088
250	220	13.8	25088
300	260	28.3	30088

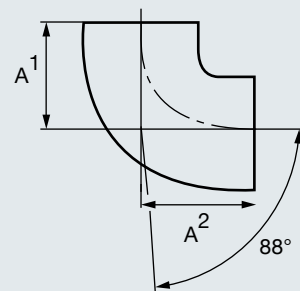

Bend 88° with 250 mm spigot

DN	A ¹	A ²	K*	kg	Item no.
100	250	110	140	4.6	10088LANG

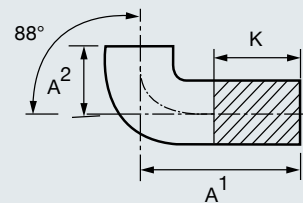

*Maximum reduction.

Double bend 88° (2 x 44°)

DN	A ¹	A ²	A ³	kg	Item no.
50	50	100	121	1.2	DB5088
70	60	120	145	1.8	DB7088
80	60	120	145	1.8	DB8088
100	70	140	170	3.2	DB10088
125	80	160	195	4.6	DB12588
150	90	180	219	7.0	DB15088

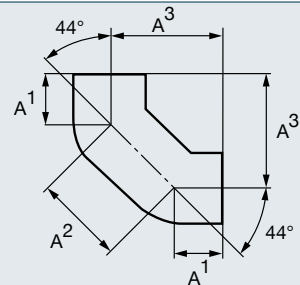

Bend with 250 mm oblong (2 x 44°)

DN	A ¹	A ²	A ³	kg	Item no.
100	70	312	291	4.8	BB10088
125	80	322	308	6.8	BB12588
150	90	334	326	9.6	BB15088

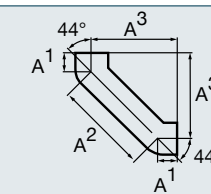

Recirculated air bend 135°

DN	A	B*	L	kg	Item no.
100	312	100	150	5.0	UB100135

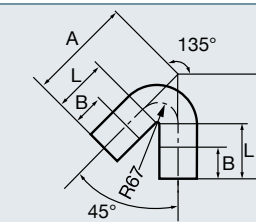

*Maximum reduction.

Offset bend 65 mm

DN	A	L	kg	Item no.
100	70	205	2.5	SPRUNGR100/65

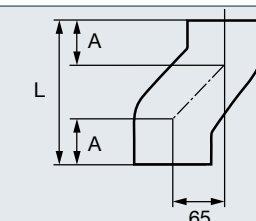

Offset bend 130 mm

DN	A	L	kg	Item no.
100	70	270	3.4	SPRUNGR100
125	70	290	4.9	SPRUNGR125

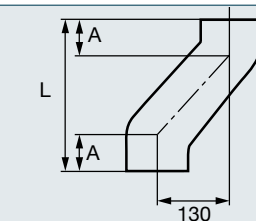

Offset bend 200 mm

DN	A	L	kg	Item no.
100	70	340	4.4	SPRUNGR100/200

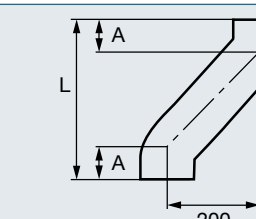

Trap – horizontal/vertical

DN	L	B	A ¹	A ²	A ³	A ⁴	C	kg	Item no.
50	190	250	182	68	122	68	60	2.8	GV50
70	265	293	200	93	172	93	60	5.0	GV70
80	265	293	200	93	172	93	60	5.8	GV80
100	325	392	282	110	215	110	100	8.5	GV100
125	390	446	316	130	260	130	100	13.0	GV125
150	470	493	348	145	325	145	100	19.5	GV150
200	600	600	420	180	400	200	100	33.7	GV200

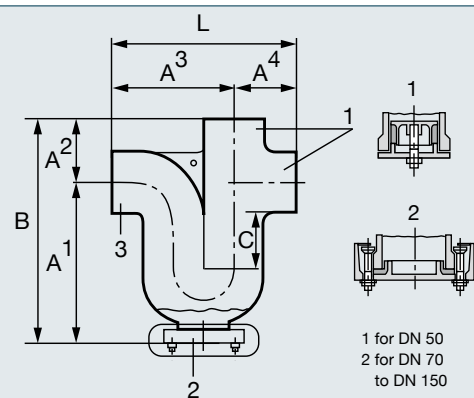

1 Inflow horizontal or vertical (seal unused intake)
2 Access door at bottom for DN 50-150
3 Outlet

Trap – vertical

DN	L	B	A ¹	A ²	D	kg	Item no.
100	588	276	90	408	124	18.5	GV100VERT
125	687	344	100	487	144	28.5	GV125VERT
150	742	374	110	522	179	38.0	GV150VERT

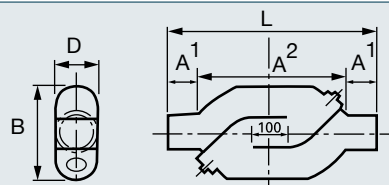

Plug

DN	L	kg	Item no.
50	30	0.2	ENDDE50
70	35	0.4	ENDDE70
80	35	0.4	ENDDE80
100	40	0.5	ENDDE100
125	45	1.1	ENDDE125
150	50	1.7	ENDDE150
200	60	3.1	ENDDE200
250	70	6.0	ENDDE250
300	80	9.5	ENDDE300

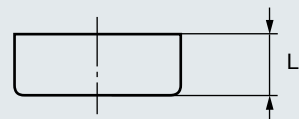

Plug with gripper clamp

DN	L	kg	Item no.
100	90	2.5	ENDDE100KL
125	90	3.5	ENDDE125KL
150	95	4.5	ENDDE150KL

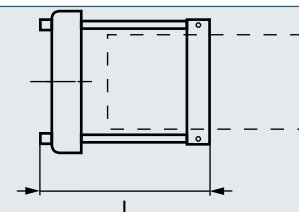

Branch 45°

DN1/DN2	A ¹	A ²	A ³	L	kg	Item no.
40/40	45	115	115	160	1.0	404045
50/40	45	115	115	160	1.1	504045
50/50	50	135	135	185	1.4	505045
70/50	40	150	150	190	1.6	705045
70/70	55	160	160	215	2.3	707045
DE75/50	40	130	130	170	1.4	755045
DE75/75	60	165	165	225	1.9	757545
80/50	55	135	135	190	1.8	805045
80/80	65	165	165	230	2.4	808045
100/50	35	165	165	200	2.5	1005045
100/70	50	185	185	235	3.3	1007045
DE100/75	50	165	165	215	3.2	1007545
100/80	55	175	175	230	3.5	1008045
100/100	70	205	205	275	4.2	10010045
125/50	20	185	185	205	3.4	1255045
125/70	40	200	200	240	4.3	1257045
125/80	40	200	200	240	4.6	1258045
125/100	60	220	220	280	5.2	12510045
125/125	80	240	240	320	6.4	12512545
150/70	30	215	215	245	5.6	1507045
150/80	40	215	215	255	5.9	1508045
150/100	55	240	240	295	6.8	15010045
150/125	70	255	255	325	8.0	15012545
150/150	90	265	265	355	9.2	15015045
200/80	15	240	240	255	8.5	2008045
200/100	40	265	265	305	10.0	20010045
200/125	55	280	280	335	11.9	20012545
200/150	75	300	300	375	13.3	20015045
200/200	115	340	340	455	17.2	20020045
250/100	15	310	310	325	15.4	25010045
250/125	35	335	335	370	17.9	25012545
250/150	55	350	350	405	20.2	25015045
250/200	90	385	385	475	25.1	25020045
250/250	130	430	430	560	31.5	25025045
300/100	5	345	345	350	22.0	30010045
300/125	15	360	360	375	23.9	30012545
300/150	35	380	380	415	26.9	30015045
300/200	70	415	415	485	34.0	30020045
300/250	115	465	465	580	42.1	30025045
300/300	155	505	505	660	50.1	30030045
400/300	105	555	555	660	60.0	40030045

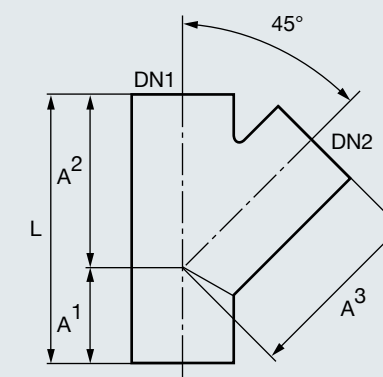

Branch 70°

(discontinued)

DN1/DN2	A ¹	A ²	A ³	L	kg	Item no.
50/50	55	80	80	135	1.0	505070
70/50	55	90	90	145	1.3	705070
70/70	70	100	100	170	1.7	707070
100/50	55	100	110	155	1.9	1005070
100/70	70	110	120	180	2.4	1007070
100/100	85	130	130	215	2.9	10010070
125/70	70	120	130	190	3.2	1257070
125/100	85	140	145	225	4.0	12510070
125/125	100	155	155	255	4.7	12512570
150/100	85	150	155	235	5.2	15010070
150/125	100	165	170	265	6.1	15012570
150/150	115	180	180	295	7.1	15015070

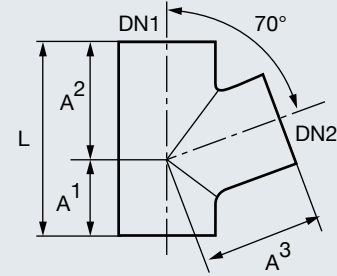

Double branch 70°

(discontinued)

DN1/DN2/DN3	A ¹	A ²	A ³	L	kg	Item no.
100/70/70	70	110	120	180	2.9	DA1007070
100/100/100	85	130	130	215	3.6	DA10010070
125/100/100	85	140	145	225	4.5	DA12510070

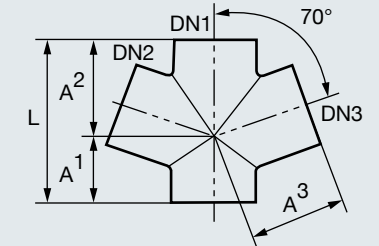

Branch 88° (Fig. 1)

DN1/DN2	A ¹	A ²	A ³	L	C	kg	Item no.
50/50	79	66	80	145	20.0	0.9	505088
70/50	83	72	90	155	21.0	1.4	705088
70/70	97	83	95	180	21.0	1.7	707088
DE75/50	83	72	90	155	21.0	1.2	755088
DE75/75	97	83	95	180	21.0	1.4	757588
80/50	95	85	90	180	21.0	1.5	805088
80/80	95	85	95	180	21.0	2.0	808088
100/50	94	76	105	170	22.0	2.1	1005088
100/70	102	88	110	190	22.0	2.4	1007088
DE100/75	100	85	111	185	22.0	2.9	1007588
100/80	105	85	110	190	22.0	2.6	1008088
100/100	115	105	120	220	22.0	2.9	10010088
125/50	98	82	120	180	25.0	3.0	1255088
125/70	107	93	125	200	25.0	3.4	1257088
125/80	110	95	125	205	25.0	3.6	1258088
125/100	125	110	130	235	25.0	4.0	12510088
125/125	137	123	135	260	25.0	4.6	12512588
150/50	100	100	140	200	27.5	4.4	1505088
150/70	115	100	140	215	27.5	4.8	1507088
150/100	130	115	145	245	27.5	5.5	15010088
150/125	147	128	150	275	27.5	6.2	15012588
150/150	158	142	155	300	27.5	6.9	15015088
200/100	144	126	175	270	32.5	8.9	20010088
200/200	188	176	180	364	32.5	12.5	20020088

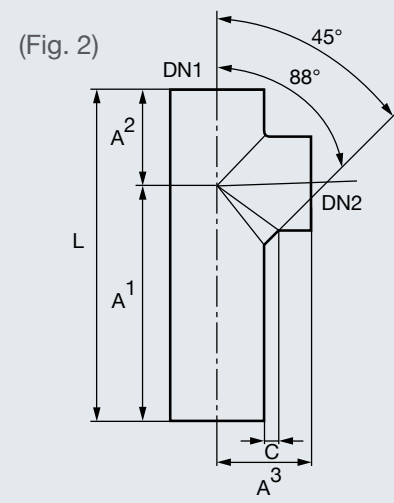
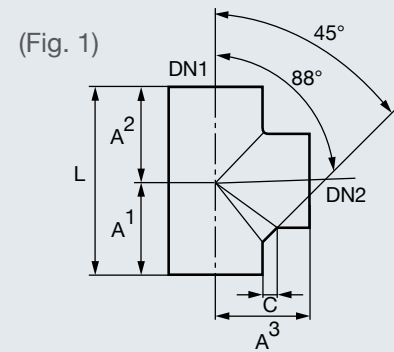

Branch 88° with long spigot (Fig. 2)

100/100	325	115	105	430	21.0	4.6	10010088LANG
---------	-----	-----	-----	-----	------	-----	--------------

Double branch 88°

DN1/DN2/DN3	A ¹	A ²	A ³	L	C	kg	Item no.
100/50/50	100	80	105	180	22.0	2.2	DA1005088
100/70/70	102	88	110	190	22.0	2.7	DA1007088
100/100/100	120	110	120	230	22.0	3.2	DA10010088
150/100/100	130	115	145	245	27.5	7.1	DA15010088

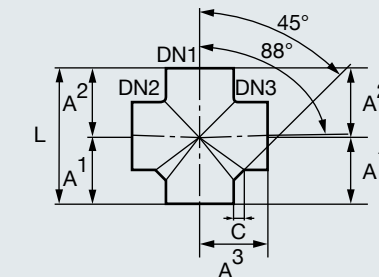

Corner branch 88° (Fig. 1)

DN1/DN2	A ¹	A ²	A ³	L	C	kg	Item no.
80/80	95	85	95	180	21.0	2.2	EA8088
100/70	102	88	110	190	22.0	2.7	EA1007088
100/100	115	105	120	220	22.0	3.4	EA10088
125/100	125	110	130	235	25.0	5.0	EA12510088
150/100	130	115	145	245	27.5	7.1	EA15010088

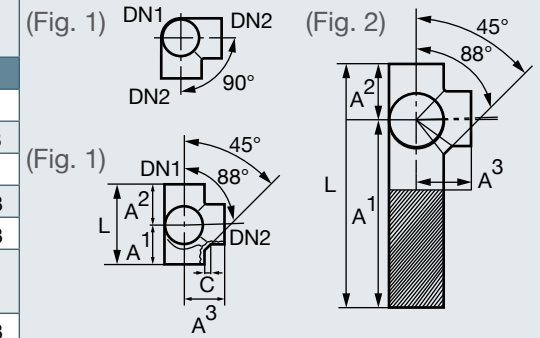

Corner branch 88° with long spigot (Fig. 2)

100/100	325	105	115	430	22.0	5.2	EA10010088
---------	-----	-----	-----	-----	------	-----	------------

Combination branch 90°

DN1/DN2/DN3	A ¹	A ²	A ³	A ⁴	kg	Item no.
100/70/100	115	140	130	70	4.5	KA1007010090
100/80/100	115	140	130	70	4.8	KA1008010090
100/100/100	115	140	140	70	5.0	KA10010010090

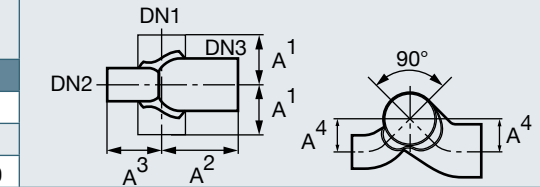

Short pipe with round access door

DN	D	B	A	L	kg	Item no.
50	59	105	53	190	2.3	REINIG50
70	69	125	73	210	2.9	REINIG70
80	74	135	78	220	3.1	REINIG80
100	84	159	104	260	5.0	REINIG100

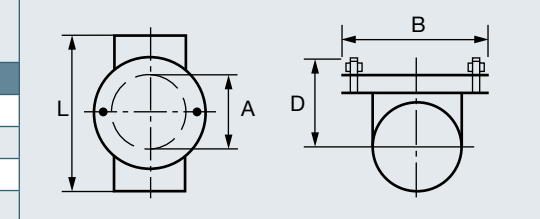

Short pipe with rectangular access door

DN	D*	B*	G	A	I	L	kg	Item no.
100	83	157	100	200	230	340	7.6	REINIG100ECK
125	101	190	125	225	255	370	10.3	REINIG125ECK
150	112	215	150	250	280	395	14.5	REINIG150ECK
200	137	265	200	300	330	465	22.0	REINIG200ECK
250	170	330	259	350	426	570	36.5	REINIG250ECK
300	195	380	309	400	476	640	51.0	REINIG300ECK

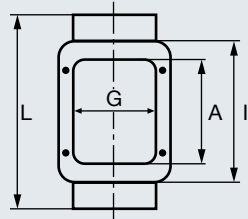

*See diagram for short pipe with round access door.

Stack support pipe (no rubber)

DN	B	A	L	kg	Item no.
50	87	96	200	1.3	FALLROH50
70	106	96	200	1.6	FALLROH70
80	114	96	200	1.8	FALLROH80
100	145	96	200	2.3	FALLROH100
125	170	96	200	3.0	FALLROH125
150	195	96	200	4.0	FALLROH150
200	245	96	200	6.0	FALLROH200
250	340	146	300	18.7	FALLROH250
300	390	146	300	24.0	FALLROH300

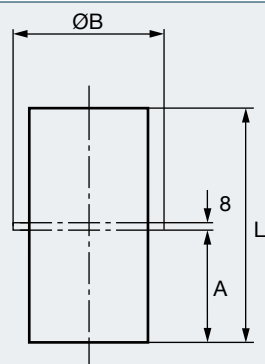

Stack support bracket (with rubber)

DN	Y ²	Y ¹	B	V	S	kg	Item no.
50	61	93	193	148	25	0.9	AUFFALL50
70	82	114	214	166	26	1.0	AUFFALL70
80	87	120	214	175	31	1.0	AUFFALL80
100	115	147	250	202	28	1.3	AUFFALL100
125	138	171	275	225	28	1.5	AUFFALL125
150	163	199	300	252	30	2.0	AUFFALL150
200	215	250	360	310	30	3.0	AUFFALL200
250	280	344	442	392	34	5.6	AUFFALL250
300	332	393	495	445	39	7.4	AUFFALL300

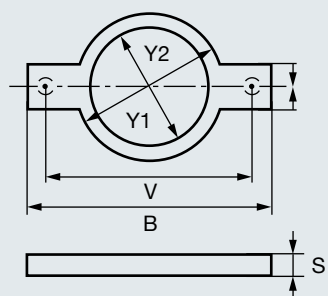

Reducing pipe eccentric

DN1/DN2	I	L	kg	Item no.
50/40	40	65	0.5	ÜBERG5040
70/50	40	75	0.5	ÜBERG7050
DE75/50	40	75	0.5	ÜBERG7550
80/50	45	80	0.7	ÜBERG8050
100/50	45	80	0.9	ÜBERG10050
100/70	45	85	0.9	ÜBERG10070
DE100/75	45	85	0.9	ÜBERG10075
100/80	45	90	1.1	ÜBERG10080
125/50	50	85	1.4	ÜBERG12550
125/70	50	90	1.5	ÜBERG12570
125/80	54	95	1.5	ÜBERG12580
125/100	50	95	1.5	ÜBERG125100
150/50	55	95	2.0	ÜBERG15050
150/70	55	100	2.1	ÜBERG15070
150/80	56	100	2.3	ÜBERG15080
150/100	60	105	2.2	ÜBERG150100
150/125	60	110	2.2	ÜBERG150125
200/100	70	115	4.1	ÜBERG200100
200/125	70	120	4.1	ÜBERG200125
200/150	65	125	4.3	ÜBERG200150
250/150	80	140	6.8	ÜBERG250150
250/200	80	145	7.0	ÜBERG250200
300/150	96	150	10.7	ÜBERG300150
300/200	95	160	11.4	ÜBERG300200
300/250	95	170	12.4	ÜBERG300250
400/300	95	180	15.2	ÜBERG400300

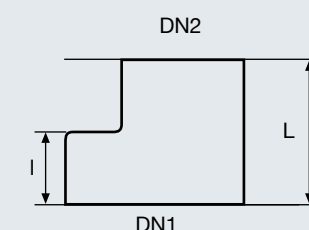

WC bend 90°

DN	A'	B	kg	Item no.
100	150	10	2.6	WC10090150

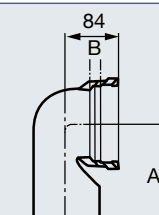

Connection bend 90°

DN1/DN2	A ¹	A ²	K ¹	K ²	kg	Item no.
40/50	200	110	120	20	1.4	OBJEKTAN40/50
50/50	200	110	120	25	1.5	OBJEKTAN50/50
60/50	200	110	120	30	1.5	OBJEKTAN60/50

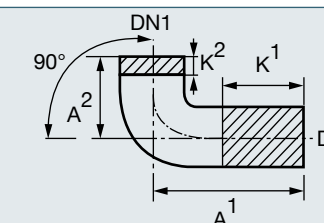

*Maximum reduction.

More parts available on request (see price list/website).

RSP® special parts

RSP® also offers its high-quality fittings in sizes other than the standard DIN dimensions.

Important!
Products may need to be specially ordered.

Please note

The fittings on the following two pages meet the same stringent quality criteria as the rest of the RSP® product range, but differ from the standard DIN EN range. RSP® special parts are therefore not normally used in Germany. They are generally used only in the United Kingdom, Scandinavia and various Asian countries.

Products made precisely to order

Do you have requirements that are not met by the products listed here? Then please speak to us. We can gladly produce RSP® special parts to your planning specifications. Nothing is out of the question, whether it is a particular set of dimensions or a special coating. This service is also available for KML, TML and BML systems.

Swept bend 88°, long/medium

DN	A ¹	a	A ²	b	kg	Item no.
100*	255	55	255	55	5.5	RB10088L
150**	250	80	250	80	8.5	RB10088M

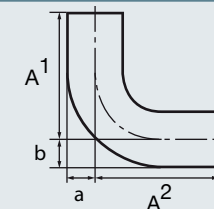

* Long swept bend ** Medium swept bend

Rest bend 88°

DN	A ¹	a	A ²	b	kg	Item no.
100	251	55	260	56	5.7	AB10088

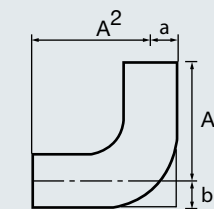

Access bend, long

DN	Type	A	r	kg	Item no.
100	Long	230	150	6.0	BR10088L

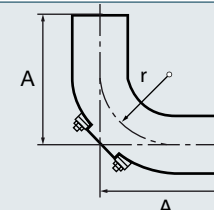

Access bend, short

DN	Type	A	B	kg	Item no.
100	Short	110	110	3.1	BR10088K
150	Short	145	145	6.1	BR15088K

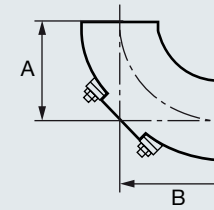

Ventilation bend 88°, radial

DN1	DN2	Ventilation	l	b	h	a	kg	Item no.
100	50	radial	169	166	59	95	2.2	LB10088R

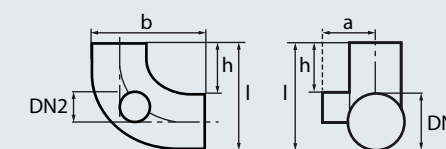

Ventilation bend 88°, axial

DN1	DN2	Ventilation	l	b	h	a	kg	Item no.
100	50	axial	169	166	59	200	2.2	LB10088A

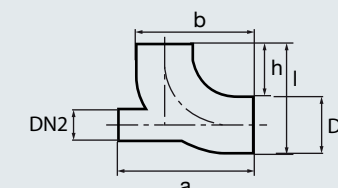

Plain trap

DN	L	A ¹	A ²	A ³	kg	Item no.
100	370	297	80	55	7.3	ES100

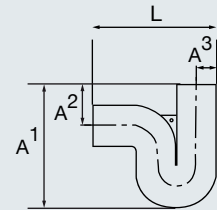

Push-in plug

DN	DE	L	h	kg	Item no.
50	64	48	15	0.25	PS050
70	85	63	11	0.50	PS070
80	90	63	11	0.55	PS080
100	118	81	26	1.00	PS100
125	143	82	29	1.50	PS125
150	168	88	35	2.25	PS150
200	218	100	37	4.20	PS200
250	284	93	40	6.20	PS250
300	336	100	44	9.00	PS300

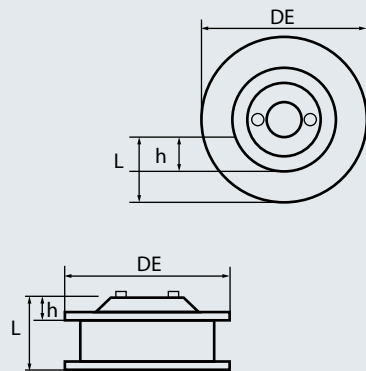

Swept entry branch 88°

(with¹ or without² access door)

DN	A ¹	A ²	c	d	L	kg	Item no.
100	168	102	150	100	270	3.7	AR10088 OR ²
100	168	102	150	100	270	4.7	AR10088 MR ¹
150	183	117	202	100	300	7.0	AR15088 MR ¹

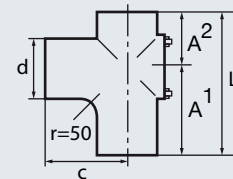

Double branch 45°

DN1/DN2/DN3	d	A ¹	A ²	L	kg	Item no.
100/100/100	100	70	190	260	4.0	DA10010045
150/100/100	100	55	225	280	5.4	DA15010045

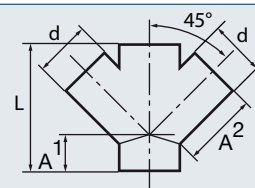

The full set of RSP® catalogues

Cast iron waste water systems, couplings, and technology and installation

Request a catalogue now!
+49 (0) 8034 70 82-0



RSP®

Well connected



SML

Socketless cast iron waste water system for building construction



BML

Socketless cast iron waste water system for bridge construction

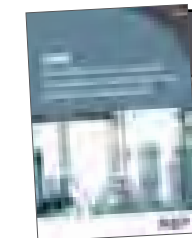

KML

Socketless cast iron system for aggressive waste water from kitchens and laboratories

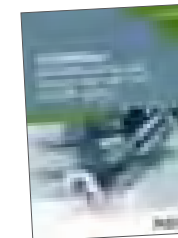

Couplings

High tensile and standard joints for SML, KML, TML and BML systems

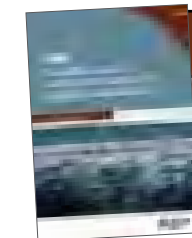

TML

Socketless cast iron waste water system for civil engineering applications



Technology and installation

What you need to know

Or download any catalogue from:
www.rsp-pipes.com

